



Digital Solutions for Energy Production and Generation Infrastructure

Accelerating the Energy Transition

Bentley®



Energy infrastructure, the fundamental driver of global industrial growth and economic development, is undergoing a radical transition that is driven by decarbonization, electrification, decentralization, and energy security needs. This energy transition is now incurring unprecedented global investment across all forms of energy production and delivery.

For nearly 40 years, a growing portfolio of Bentley products and solutions has improved innovation, optimization, collaboration, and mitigation of critical industrial-scale energy production infrastructure, helping to accelerate the transition to net zero through going digital.

Why Digital Twins Are Driving the Energy Sector

It is common knowledge that energy infrastructure is aging, difficult to update with reliable information, and often situated in remote locations.

Meanwhile, new renewable and carbon-efficient energy projects are growing around the world as the energy transition accelerates.

What is critical to both old and new energy projects is that they need to prioritize safety, reduce risk, enable effective decision-making, and save costs—both financial and environmental.

To do their job faster and more efficiently, energy utilities need innovative technologies and processes. Therefore, many of them are adopting digital twins.

With digital delivery, projects are delivered using digital models, data, and supporting field applications for energy infrastructure design, analysis, construction, and into operations. Digital delivery incorporates streamlined processes to manage asset information as it changes through project development across the asset lifecycle. With this delivery method, it is easier to review the design intent and develop high-resolution 3D design visuals, providing improved design quality.

It can make a significant impact on reducing project cost overruns, and the 3D design enables designers to run what-if scenarios, such as structural or geotechnical, to test different conditions and optimize project cost before handover.

One of the main strengths of a digital twin is its ability to be a multidiscipline data collaboration and data management interface to various data sources, from 3D models and reality meshes, to data from IoT sensors, and represent its near real-time status, working condition, or position. Throughout the lifecycle of an asset, a digital twin helps you to:

- ◆ Understand existing conditions
- ◆ Improve and accelerate design and construction workflows
- ◆ Increase asset reliability and performance
- ◆ Visually enhance collaboration

[LEARN MORE >>](#)

What Are the Benefits of Using Digital Twins?

In Planning

- ◆ Assess and understand existing conditions (aboveground and belowground)
- ◆ Identify asset needs
- ◆ Identify project requirements
- ◆ Manage and mitigate risk
- ◆ Manage asset performance
- ◆ Optimize collaboration and coordination with stakeholders and citizens
- ◆ Understand financial impact early

In Design, Engineering, and Analysis

- ◆ Accelerate project delivery
- ◆ Evaluate project impact
- ◆ Optimize collaboration and coordination with stakeholders and citizens
- ◆ Reduce risk, project costs, and delays
- ◆ Simulate design options
- ◆ Reduce redesigns and rework



What Are the Benefits of Using Digital Twins?

In Construction and Commissioning

- ◆ Improve safety and enable right-first-time construction
- ◆ Increase construction efficiency
- ◆ Manage project schedule versus performance
- ◆ Monitor and track progress
- ◆ Optimize collaboration and coordination with stakeholders and citizens
- ◆ Provide up-to-date documents
- ◆ Reduce on-site visits

In Operations and Maintenance

- ◆ Develop more repeatable assessment processes
- ◆ Ensure regulatory compliance
- ◆ Enhance worker safety
- ◆ Improve asset performance monitoring
- ◆ Lower asset operational costs
- ◆ Optimize collaboration and coordination with stakeholders and citizens
- ◆ Reduce on-site visits and asset downtime
- ◆ Virtually assess and document assets



The following use cases demonstrate how users around the world are leveraging digital twins to synchronize work, gain greater visibility, and make sense of the right data at the right time across the lifecycle of assets.

Hydrocarbons

Deepwater Project Delivery Digital Platform 
OQ Asset Reliability Digitalization With Purpose

Associated Sector – *Hydrogen*

Executive Design of the Pipelines for the Hydrogen Generator Cooling System 

Renewable Generation – *Offshore Wind*

Block Island Wind Farm 

Renewable Generation – *Solar*

Suixian and Guangshui 80MWp Ground-based Photovoltaic Power Project 

Power Generation – *Experimental Nuclear Fusion*

The World's Largest Tokamak, A Magnetic Fusion Device 

Renewable Generation – *Wave and Tidal*

Offshore New Energy Utilization Research and Development Project 

Power Generation – *Natural Gas Power Plant*

Port Moresby Power Station 

Energy Storage – *Geotechnical*

Reducing The Environmental Impact of Lithium Extraction with Subsurface Modelling 

Energy Distribution – *District Heating*

Converting Electricity Generation to Renewable Energy 

Hydrocarbons | WINNER
2022 *Going Digital* Award in Process and Power Generation

OQ Asset Reliability Digitalization With Purpose

OQ Upstream
Oman

OQ, an integrated energy company, operates and manages dozens of plants, thousands of assets, and over 4,500 kilometers of pipeline across Oman. To improve asset performance and reliability and ensure safe and reliable plant operations, OQ wanted to digitize asset management processes. Scattered paper asset data records and previous reactive maintenance methods proved costly and ineffective. OQ realized that they needed to establish a centralized digital asset performance management (APM) system.

They selected AssetWise as their central asset data management platform, incorporating failure reporting and analysis, asset health indicators, and digital inspection strategies to enable corrective maintenance management. Their digitized APM system reduced asset failures and unplanned plant shutdowns, minimizing environmental risks of flaring. Based on APM implementation at one compressor site, the digital solution saved 14.8% in total maintenance costs and reduced functional failures by 50% to achieve an annual operational reliability growth of 4.3%. Continuing to digitize, OQ is integrating APM as part of their efforts to develop a digital twin.

Project Playbook: AssetWise® Asset Reliability

[LEARN MORE >>](#)



Hydrocarbons | FINALIST
2022 *Going Digital* Award in Process and Power Generation

Deepwater Project Delivery Digital Platform

Shell Projects and Technology
Gulf of Mexico

Shell identified a portfolio of projects in the Gulf of Mexico to deploy an integrated project delivery digital platform, continuing top cost performance while also working toward meeting net zero carbon goals and further improving project cycle times for deep water projects. This end-to-end digitization from concept design, to handover, to operations presented challenges, including how to integrate multisourced data. To achieve their goal, Shell needed open, interoperable technology applications.

Leveraging, amongst others, PlantSight and AssetWise ALIM, Shell developed a digital platform that provides a single source of truth from project conception through delivery of a digital twin for operations and beyond. Working in an integrated digital environment optimizes data access, visualization, and remote collaboration, improving efficiencies, reducing time for project teams to find information by 50%, and eliminating work duplication. By digitizing workflow orchestration and supporting end-to-end project delivery, Shell expects to see significant productivity gains and cost savings. The PlantSight digital twin solution can be scaled as projects expand or new ones arise.

Project Playbook: iTwin® Experience, SYNCHRO™, AssetWise ALIM

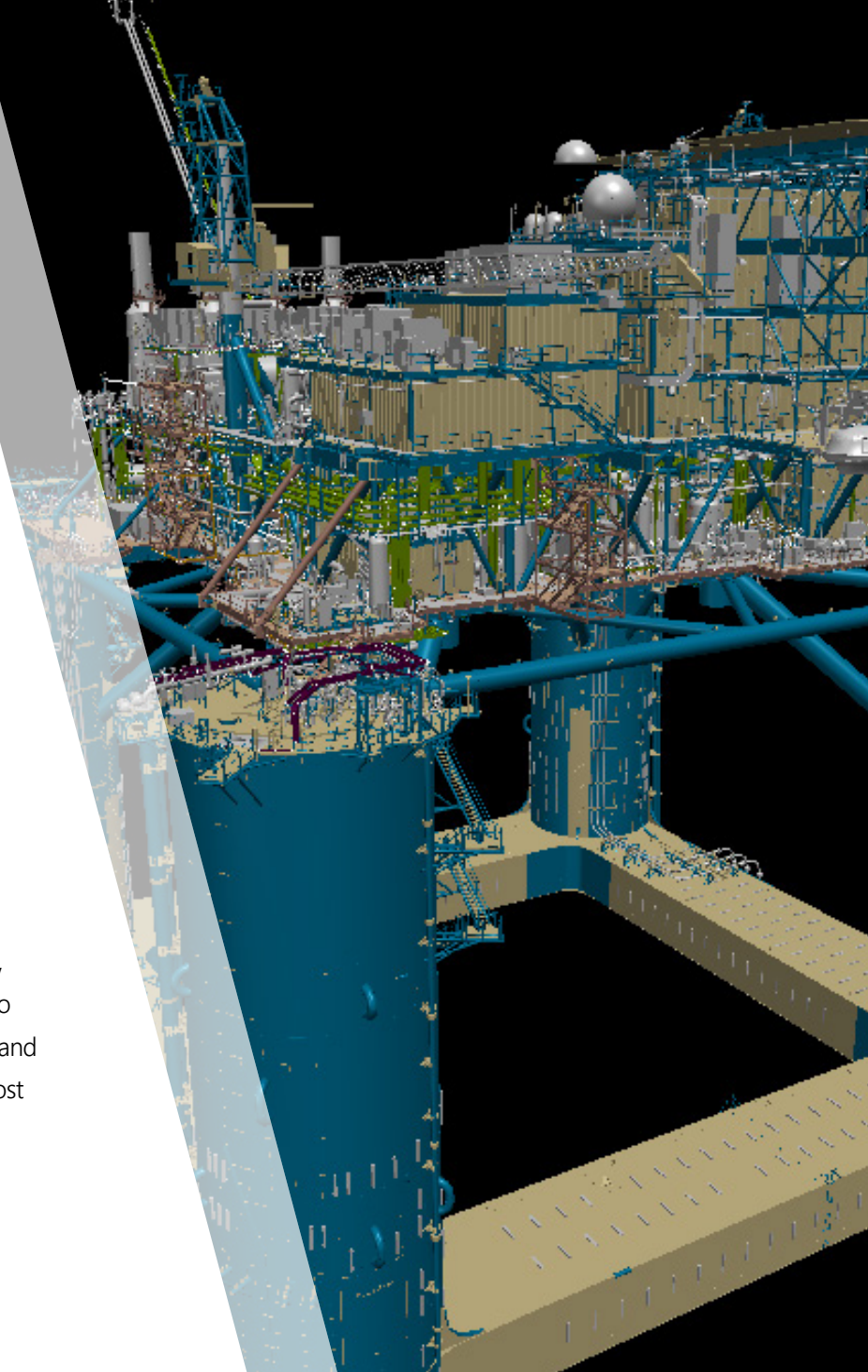

Associated Sector – Hydrogen | NOMINEE
2019 *Going Digital* Award in Power Generation

Executive Design of the Pipelines for the Hydrogen Generator Cooling System

Energoprojekt-Katowice SA
Stalowa Wola, Podkarpackie, Poland

In Stalowa Wola, Poland, a combined heat and power plant needed a hydrogen cooling system design for a 300-megawatt gas turbine generator. It was determined during construction of the combined cycle gas turbine unit that the existing hydrogen cooling system needed to be upgraded. The project required 3D modeling of the existing site conditions, pipelines, and equipment to design the plant to fit within a compact space. The project team needed to overcome these challenges while also quickly creating design deliverables.

The team established an open, connected data environment using ProjectWise, OpenPlant, and OpenBuildings Designer. Working in this open environment streamlined workflows and achieved an open-model format with all the necessary plant data included in the building design. With the support of point clouds and Bentley's integrated technology, the team designed the plant within the tight space. The solution saved significant time, facilitated efficient modeling processes, and automated generation of 2D deliverables and bills of material.

Project Playbook: AutoPIPE®, OpenBuildings®, OpenPlant®, ProjectWise®

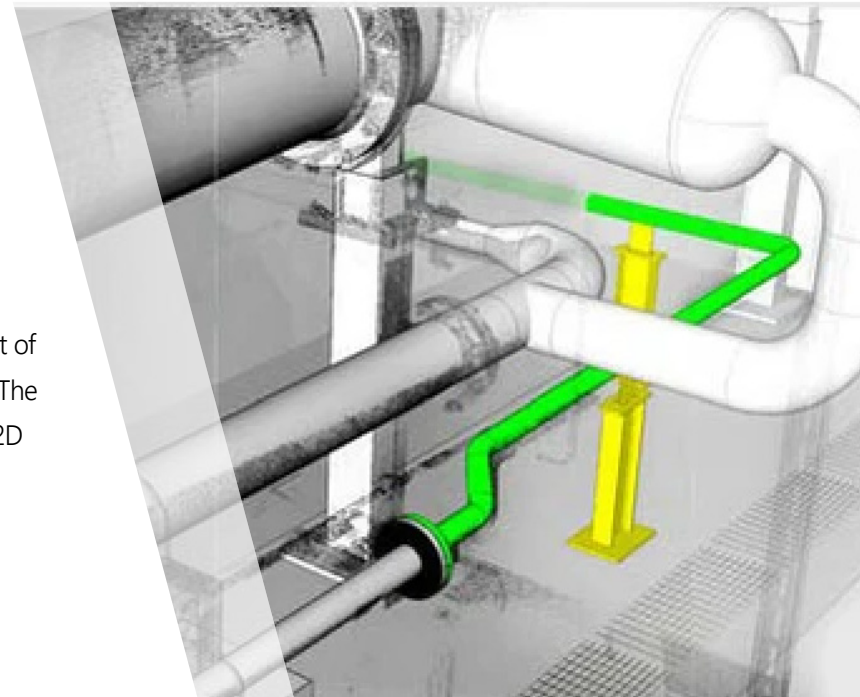

Renewable Generation – Offshore Wind | WINNER
2015 Year in Infrastructure Awards in Offshore

Block Island Wind Farm

Keystone Engineering Inc.
Rhode Island, United States

As part of the USD 290 million Block Island Wind Farm project, Keystone Engineering was retained to design the substructures for five, 6-megawatt wind turbine generators. To accommodate the complex aerodynamic and hydrodynamic loading of the deep-water wind turbines and streamline communication with the generator designer, Keystone needed flexible, interoperable offshore design and analysis tools.

Keystone leveraged Bentley OpenWindPower Fixed Foundation (formerly SACS Wind Turbine) to adapt steel jacket foundations used in the oil and gas industry as the design for the deep-water wind turbine support structures. OpenWindPower enabled Keystone to design the composite construction and complex nodal geometry for the jacket substructures, delivering an alternative to typical offshore wind monopile concrete foundations that are limited to more shallow water depths. Using Bentley OpenWindPower for its jacket design process enabled Keystone to optimize the amount of steel needed for the substructure, reducing installation costs by over 20% compared to traditional monopile construction. Bentley OpenWindPower also allowed Keystone to perform, in parallel, multiple simulations and numerous design iterations, shortening the design cycle by 50%.

Project Playbook: OpenWindPower®

[WATCH VIDEO >>](#)

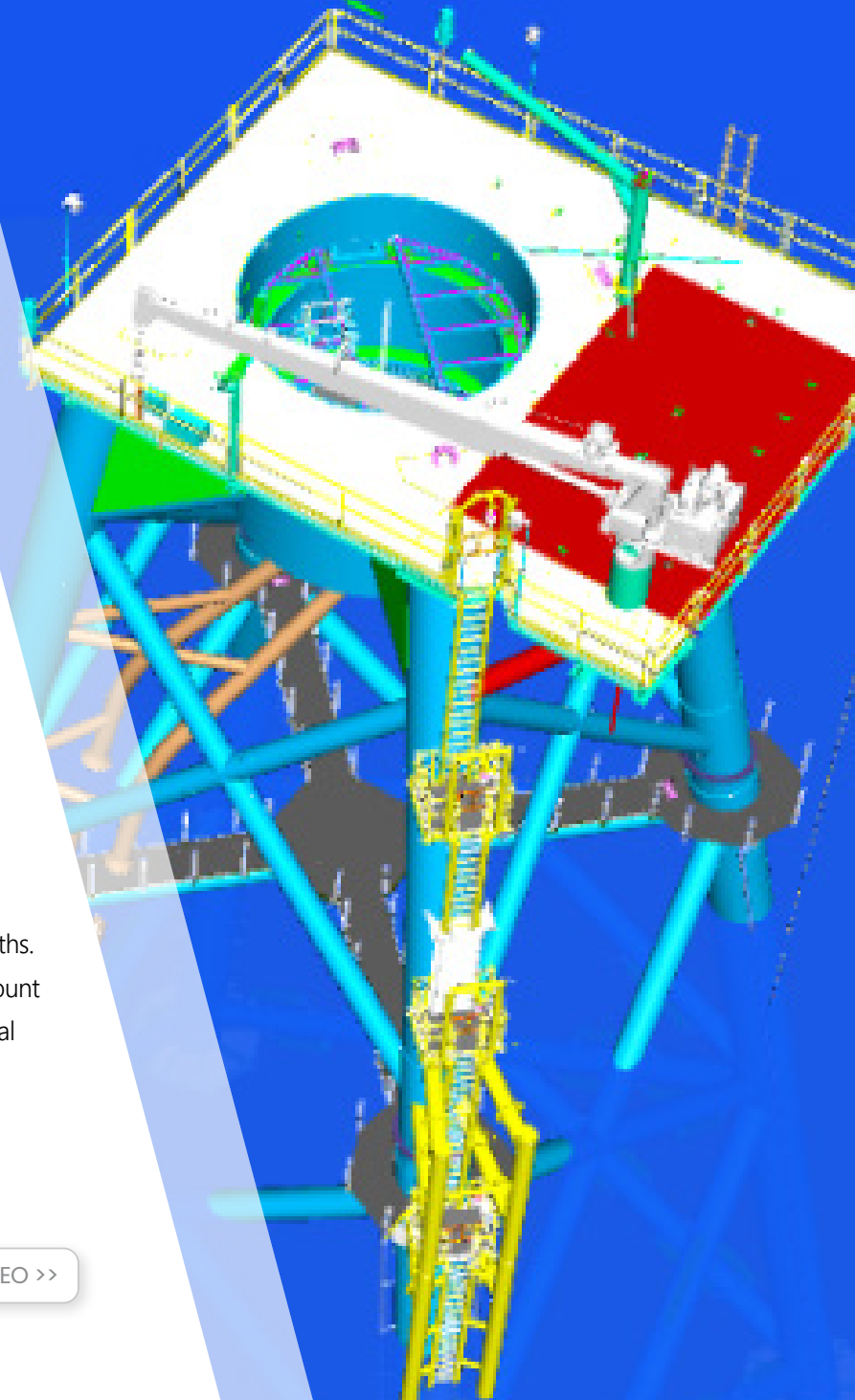

Renewable Generation – Solar | WINNER
2021 *Going Digital* Award in Utilities and Communication

Suixian and Guangshui 80MWp Ground-based Photovoltaic Power Project

POWERCHINA Hubei Electric Engineering Co., Ltd.
Guangshui, Hubei, China

When POWERCHINA Hubei Electric Engineering was hired as the engineering, procurement, and construction contractor to deliver an 80-megawatt ground-based photovoltaic power station, they faced several challenges concerning saving land, capacity, optimizing design plans, geological issues, environmental concerns, project quality, time constraints, and costs to realize lifecycle digital twin application. As a result, choosing a proper location for the photovoltaic array, booster station, access road, and the transmission line was critical to produce an optimal design.

POWERCHINA Hubei selected OpenBuildings Designer and OpenRoads for 3D modeling, as well as ProjectWise for collaborative design management. Using the robust solution, they were able to reduce design errors and manual verification, which produced a more efficient design. The solution optimized the design scheme, reducing land occupation and avoiding 40 potential rework scenarios to save more than CNY 800,000. Integrating SYNCHRO 4D accelerated construction by approximately 30 days. They used the iTwin Platform to automatically generate digital twin models, avoiding approximately CNY 1 million in costs had the digital twins been developed at the operation stage.

Project Playbook: OpenBuildings Designer, OpenRoads™, ProjectWise, SYNCHRO 4D

[LEARN MORE >>](#)

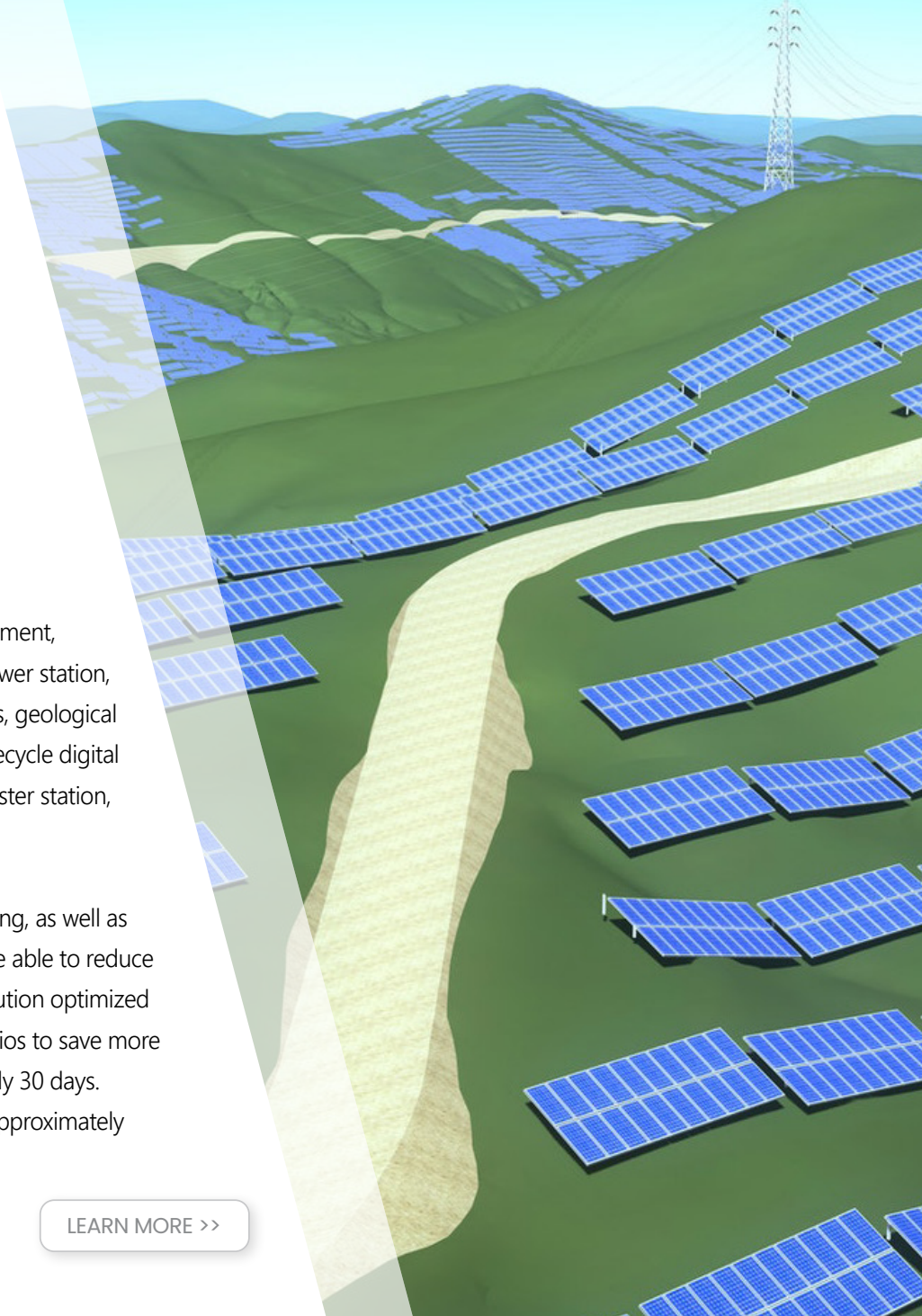

Power Generation – Experimental Nuclear Fusion

The World's Largest Tokamak, A Magnetic Fusion Device

ITER

Saint Paul-lez-Durance, France

New infrastructure, especially critical infrastructure, is designed and built to include a broad variety of digitally enabled components and materials. Digitally enabled infrastructure assets are meant to provide and even consume a rich stream of data from day one. This data includes not only asset status, but also operational data such as automatic incident detection, air quality and temperature, and energy consumption. The ITER project is building the largest tokamak fusion reactor in the world, with the goal to assess the feasibility of this energy source for large-scale, carbon-free energy generation. This project is a remarkable example of an infrastructure asset that needs to be digitally enabled by design, as it cannot operate without an AI system that is fed by an extensive array of sensors to safely control the plasma inside the nuclear fusion reactor.

Project Playbook: iTwin

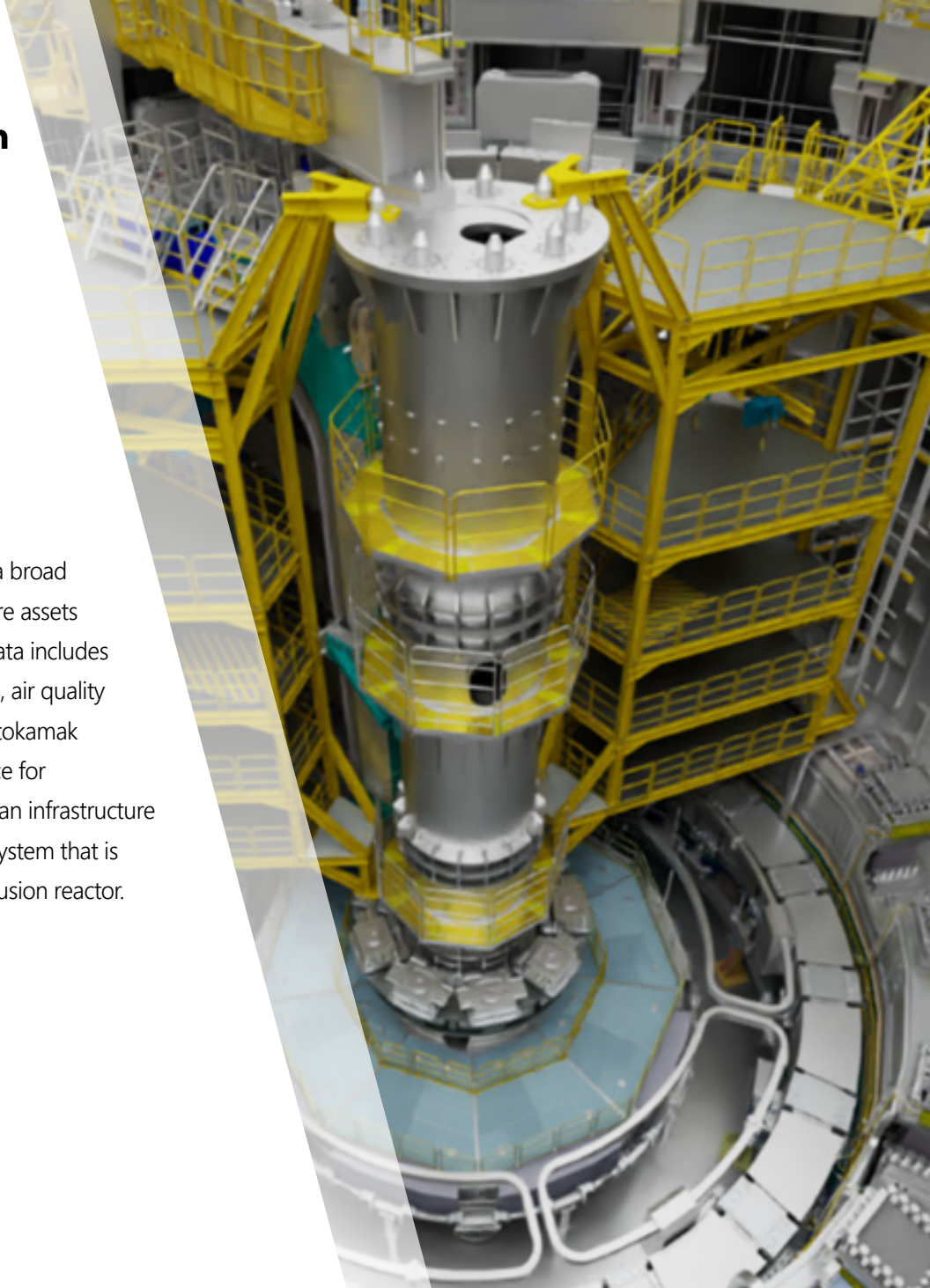

**Renewable Generation –
Wave and Tidal | NOMINEE**

2014 Year in Infrastructure Awards in Offshore Engineering

Offshore New Energy Utilization Research and Development Project

Guodian United Power Technology Co., Ltd.
China

Guodian United Power Technology Co., Ltd. (United Power) launched an offshore energy utilization project to develop tidal current and wind energy. The CNY 5.3 billion Phase 1 project includes an experimental prototype tidal current energy project off the coast of Zhoushan, Zhejiang, China, and a wind turbine project offshore of Leting, Hebei, China. Preliminary planned capacity is 300 megawatts, and overall planned capacity is 4,400 megawatts.

Guodian United Power used OpenWindPower to design the foundation and support structures. The three-pile jacket-type tidal current set weighed 700 tons. OpenWindPower performed modeling, hydrodynamic force calculation, and analysis of working conditions. For the six-pile jacket-type wind turbine set, OpenWindPower performed strength analysis, modal analysis, and fatigue analysis. Calculations for 459 fatigue working conditions took only 30 hours, saving labor and material costs.

Project Playbook: OpenWindPower

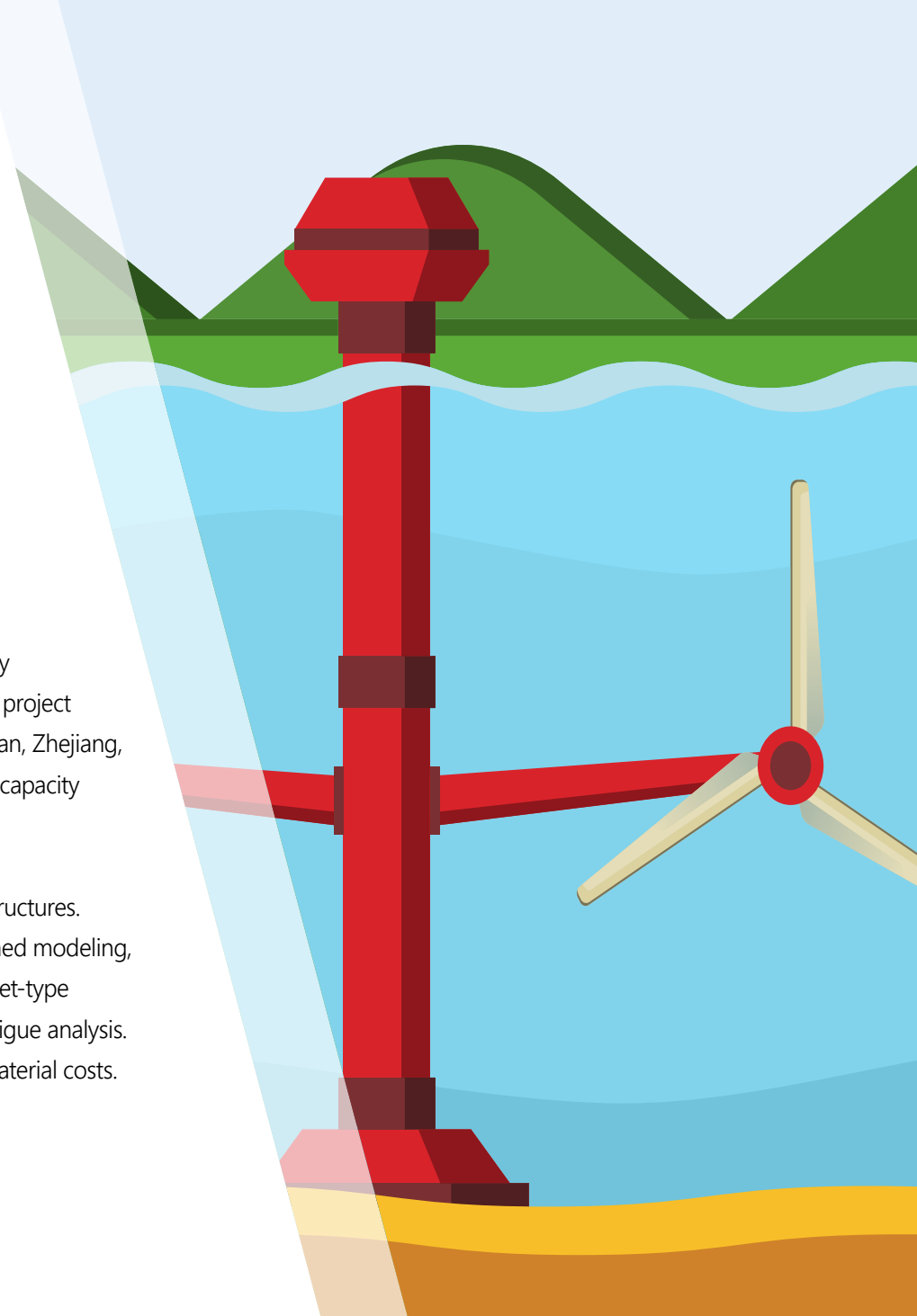

Power Generation – Natural Gas Power Plant

Port Moresby Power Station

Clough

Port Moresby, Papua New Guinea

To create Papua New Guinea's first utility-scale natural gas power plant, Clough, in a joint venture with Wartsila, provided engineering, procurement, and construction services for the project. However, Clough soon realized that effectively planning, tracking, and executing their work in a remote location presented a significant challenge. They determined that instituting lean principles on the project would help them optimize their work, eliminate waste, improve their processes, and generate value.

Clough discovered that SYNCHRO Perform would allow them to establish a unified, digital workflow that instituted lean principles and improved all aspects of the project. Supervisors and engineers began using the application to capture a variety of information on-site via web and mobile devices, including site conditions, health and safety compliance, delays, photos, workforce attendance and timesheets, and equipment usage. Revealing and highlighting problems in advance allowed the project team to quickly resolve them, preventing them from becoming major issues that could have resulted in costly rework. They were also empowered to log and then swiftly resolve more than 200 unplanned site events, keeping the project on track even when it was accelerated. POM Power Station was completed on time and now significantly reduces the carbon footprint of Papua New Guinea's energy generation.

Project Playbook: SYNCHRO Perform



Energy Storage – Geotechnical

Reducing The Environmental Impact of Lithium Extraction with Subsurface Modelling

Cornish Lithium
United Kingdom

Cornish Lithium's innovative and sustainable approach to lithium extraction sets a new standard for more environmentally friendly lithium exploration. By creating 3D geological models with Leapfrog, integrating geophysical data with Oasis Montaj, and managing their models and data using Seequent Central, they reduced their drilling to a single exploration borehole in a site through the accuracy of their predictions, and minimized their environmental impact.

Seequent software was essential to the exploration process, helping make it more eco-friendly non-invasive by digitizing archival data with the use of geophysical data sets to create 3D geological models. Geomontaj allowed them to process the geophysics, while Leapfrog helped with the visualization of the models. All geotechnical information was then brought into Seequent Central, which allowed easy transfer of work and collaboration among different teams, particularly tracking version control. The whole process allowed Cornish Lithium to access new sites more quickly using only one borehole, minimizing the impact of exploration.

Project Playbook: Oasis Montaj®, Seequent® Central, Leapfrog® Geo, Leapfrog Works

[LEARN MORE >>](#)

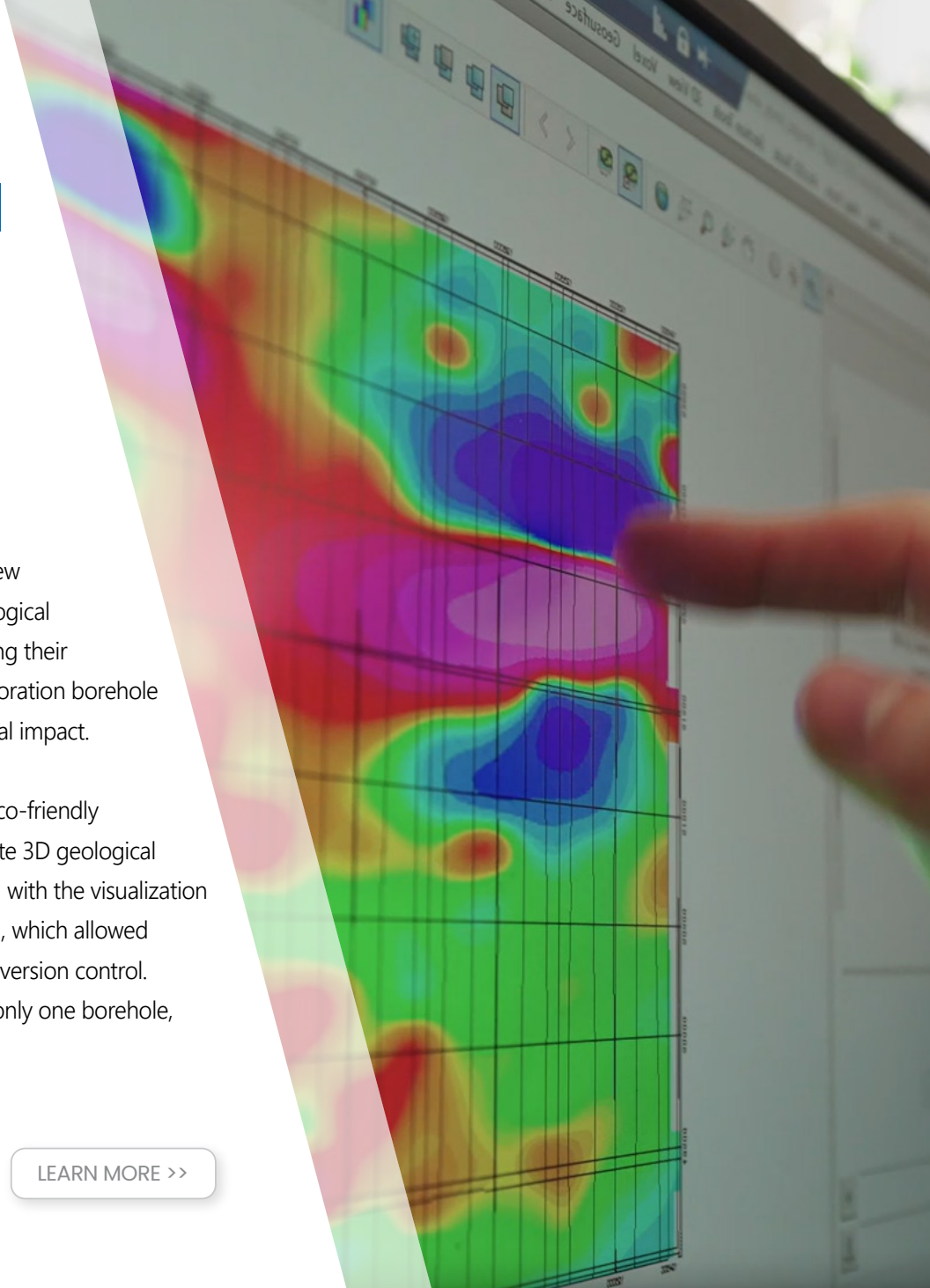

Energy Distribution – District Heating

Converting Electricity Generation to Renewable Energy

Stadtwerke Schwäbisch Hall GmbH
Germany

Stadtwerke Schwäbisch Hall GmbH is an innovative expanding public utility based in Schwäbisch Hall, Germany. It generates electricity and heat in combined heat and power plants (CHP) and power generation plants from renewable energy, supplying electricity, natural gas, heat, and water to approximately 500,000 customers. As part of carbon dioxide reduction and the EEG Renewable Energy Sources Act, Stadtwerke Schwäbisch Hall relied on an energy mix, and the increased use of renewable energies, with the share of renewable energies in the heating plants increased from 11% in 2012 to more than 50% currently. By 2030, Stadtwerke Schwäbisch Hall wants to convert electricity generation in the region to 100% renewable energy.

The challenge was to map the entire network in the future to the low-voltage grid in PSS® SINCAL. Data from the existing GIS OpenUtilities sisNET® from Bentley Systems, as well as estimated consumption and feed-in data. The data transfer and continuation typically took place mainly manually, which was considerable effort. Stadtwerke Schwäbisch Hall and Bentley Systems have agreed on a pilot project using the new software OpenUtilities Analysis from Bentley Systems. The goal is to help simplify redundant management of data.

Project Playbook: OpenUtilities®

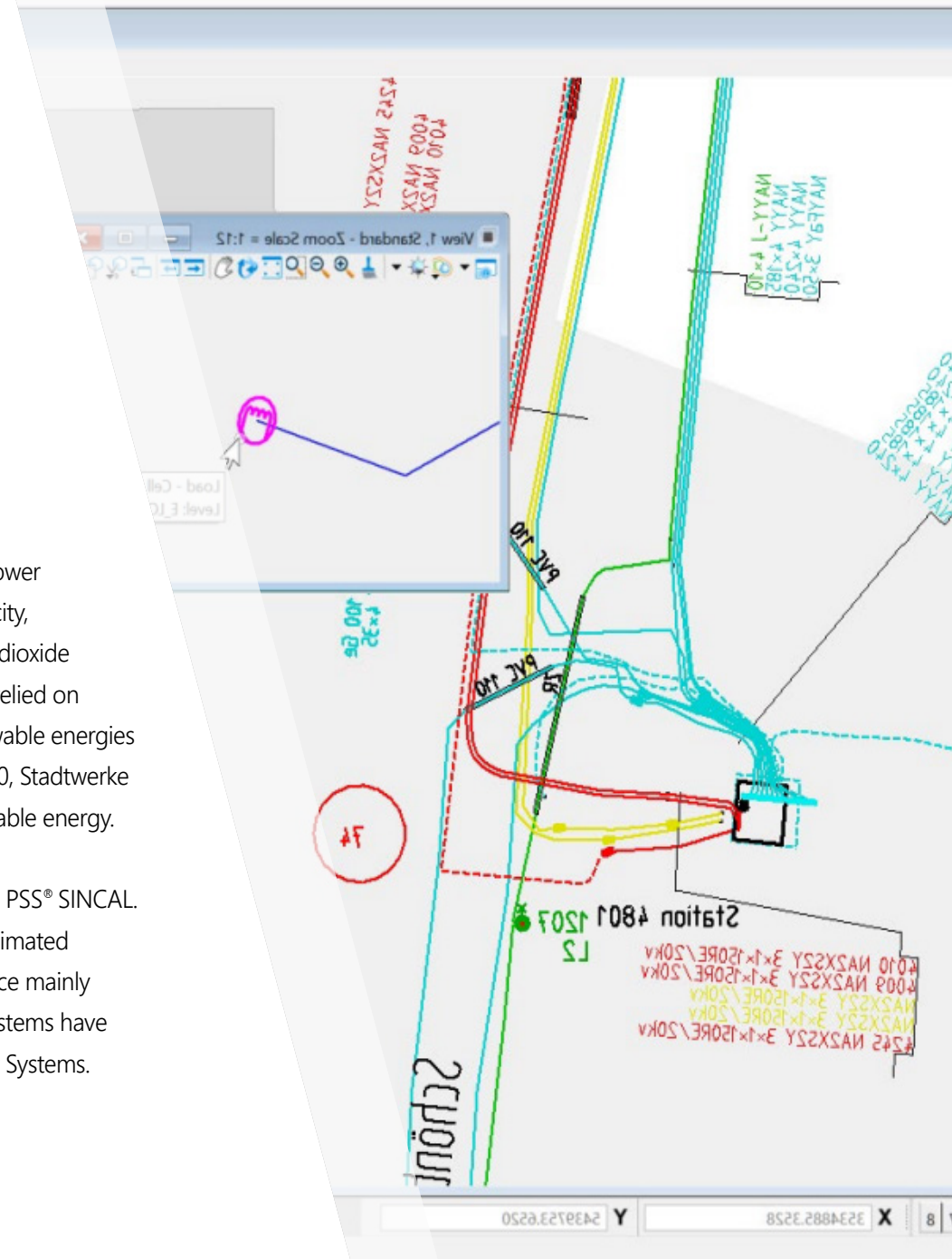



Enabling Intelligent Energy Delivery During the Energy Transition

Industrial-scale wind and solar, as well as grid-edge technologies—such as photovoltaics, storage, and electric vehicles—have rapidly grown in recent years. It will continue to do so as demand and capacity also increases. The successful integration and deployment of clean-energy investment will depend heavily on the availability of traditional, large-scale grid infrastructure—including transmission and distribution networks, switching stations, and transformers—as well as on enabling infrastructure, such as offshore wind ports. It is important for an upgraded and expanded electric grid to be the backbone of the energy transition.

In the United States alone, Princeton estimates that the electricity transmission system will need to expand by 60% by 2030.¹ This expansion is the equivalent of saying that a century of work will need to be completed in less than a decade.

Therefore, we are seeing more examples of utilities increasingly turning to agile, cloud-based solutions to manage these diverse assets, to strengthen grid reliability and improve operational safety and efficiency.

[LEARN MORE >>](#)

Bentley[®]

Advancing Energy Production Infrastructure

**Digital technology to help guide you towards
infrastructure intelligence and being future ready.**

Bentley's proven multidiscipline software delivers innovative solutions for complex energy production projects around the globe through a combination of engineering design and analysis software. Since Bentley's applications are fully integrated, open, and scalable, it is easy to get started with solutions that support your project's entire lifecycle.

To learn more about Energy Production,
[Click Here](#) →

Bentley®

© 2023 Bentley Systems, Incorporated. Bentley, the Bentley logo, AssetWise, AssetWise Asset Reliability, AssetWise ALIM, iTwin, SYNCHRO, SYNCHRO 4D, AutoPIPE, OpenBuildings, OpenBuildings Designer, OpenPlant, ProjectWise, OpenWindPower, OpenWindPower Fixed Foundation, OpenRoads, OpenRoads, Oasis Montaj, Seequent Central, LeapFrog, Leapfrog Geo, Leapfrog Work, OpenUtilities, sisNET, and GIS OpenUtilities sisNET are either registered or unregistered trademarks or service marks of Bentley Systems, Incorporated or one of its direct or indirect wholly owned subsidiaries. Other brands and product names are trademarks of their respective owners. 443150-23

